

CREATIVE LIGHTING



TUÑG
STENE

MADE IN MONTREAL

Founded in 2016, Tungstene Creative Lighting is a Montréal-based studio specializing in the design, production and sale of creative, practical and versatile lighting fixtures.

We offer a wide range of locally crafted “ready-to-customize” products and a tailored design service for your small- or large-scale projects.



UNIQUE

Each product is handcrafted
to its own design

Tungstene is a Montréal-based studio specializing in the design and production of creative and sustainable handcrafted lighting fixtures.

The company offers a wide range of adjustable products, including: ceiling lights, pendant lights, table and floor lamps, goosenecks and wall lamps.

With our custom lighting design service, we can create the perfect lighting to enhance the unique character of any project, large or small.

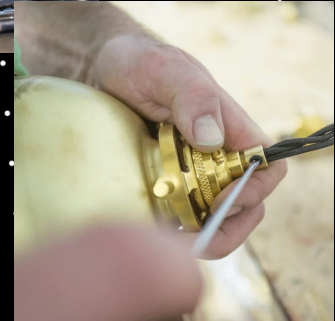

STRIKING THE PERFECT BALANCE BETWEEN STYLE AND PRACTICALITY .

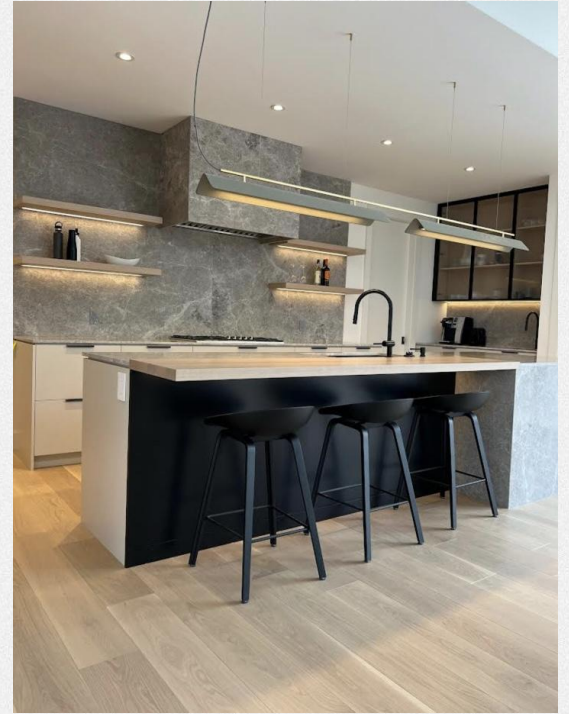

STUNNING,
VERSATILE
LIGHTING
DESIGN

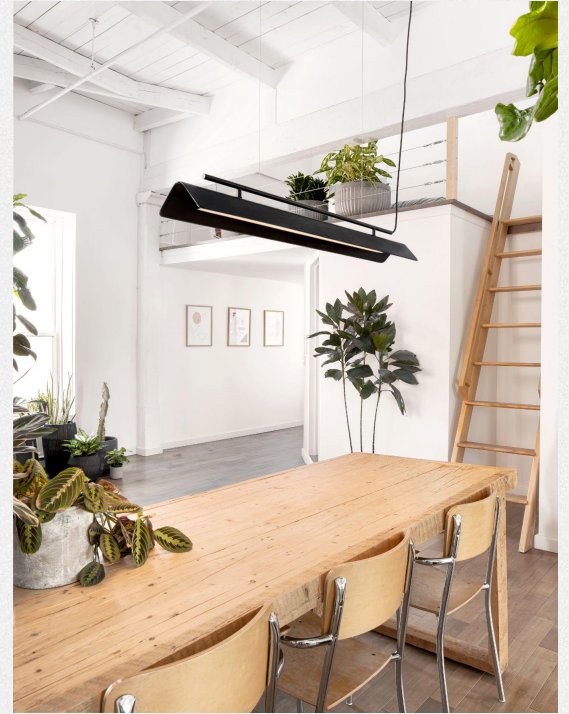

INSPIRED BY LOCAL MATERIALS AND QUEBEC KNOW-HOW



Linear
Saint-Clair marble



Sugar maple wood



Carved piece
of white oak





JANI THIBEAULT

President and Founder

Known as a strong-minded, creative woman, Jani Thibeault now works with North America's most influential designers and craftspeople to create innovative, high-quality lighting fixtures.





COLOURFUL AND CUSTOM DESIGNED

Tungstene offers range of options to customize your lighting fixtures:
finish colours, wire styles, stem designs, etc.

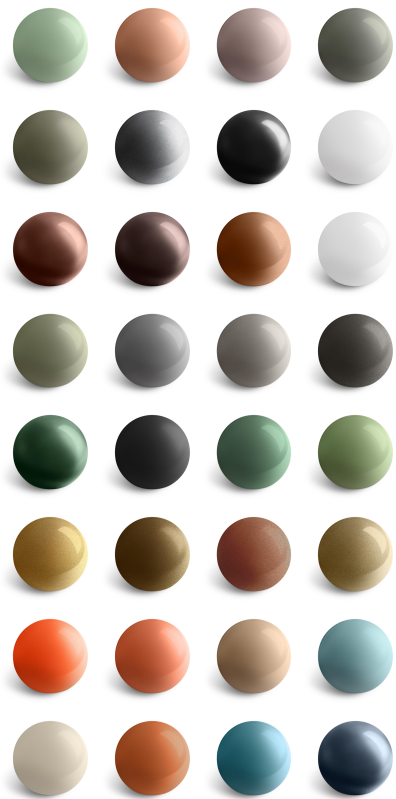

ALL THE INFORMATION YOU NEED IN ONE PLACE

tungstene.ca

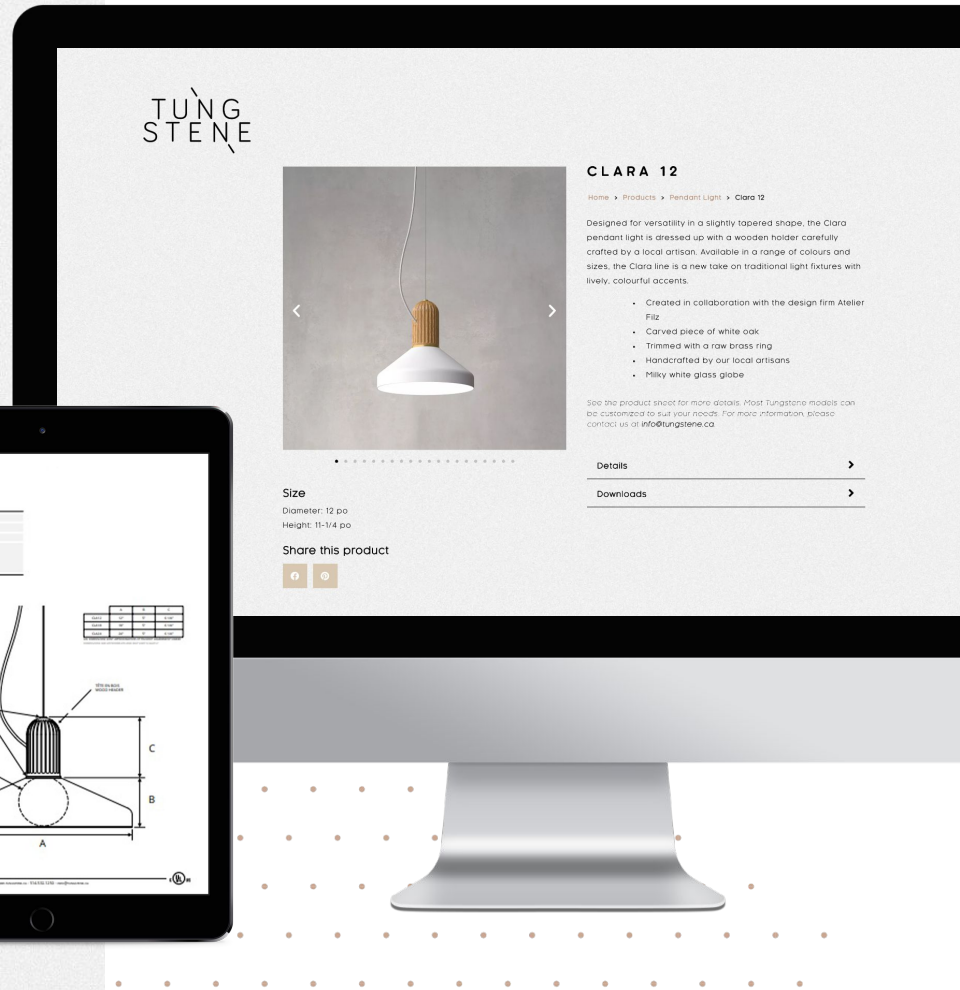
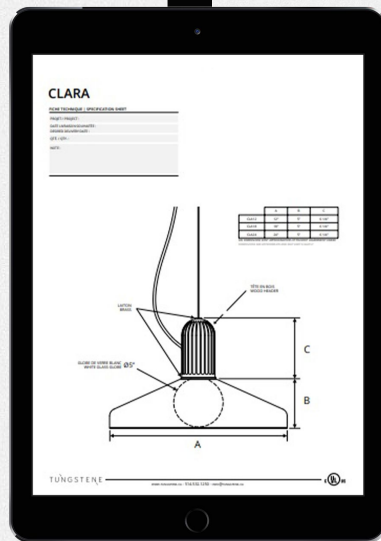

DESIGNERS' TOOLS

A sample box of our finishes is available upon request.





CUSTOM-MADE PROJECTS

Building on our expertise in custom-made design, we create lighting fixtures that suit all your project needs.

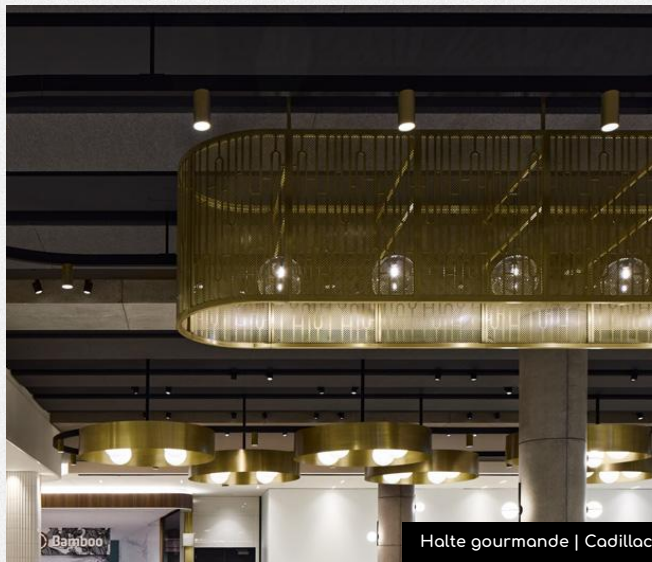



COLLECTIONS

Driven by a strong desire to create unique pieces of work, our team is working unfailingly to design new lighting fixtures that are both stunning and practical.



EMILIE LINEAR

Featuring a range of design options

Bent plywood design

LED, Dim to warm (2200K - 3000K)

Size: 48 in, 108 in



BENEDICT 28

Carved piece of white oak

Trimmed with a raw brass ring

Milky white glass globe

Size: 12 in, 20 in, 28 in



BENEDICT 12 SURFACE

Satin varnished piece
of white oak

Milky white glass globe

Size: 12 in, 20 in, 28 in



FOUCAULT 06 MARBLE M29

Accent piece carved in linear
North American Saint-Clair marble

Trimmed with a raw brass ring

Directional lampshade



ELLEN 05 M1A



KÄTHE CASCADE

Accent piece carved in Quebec
sugar maple wood

Powder-coated aluminium cylinders

Light source: G9 LED bulb included



CLARA 12 M21

Carved piece of white oak
or colour lacquered

Directional lampshade

Milky white glass globe



WIDE RANGE OF CHOICES



TUNG STENE